





BEST CLEAN

IP65   3 x 2,5  5 x 2,5 DALI  

ERIKOISTILAVALAISIN | SPECIALARMATUR | LIGHTING FIXTURES FOR SPECIAL SPACES

Best Clean A

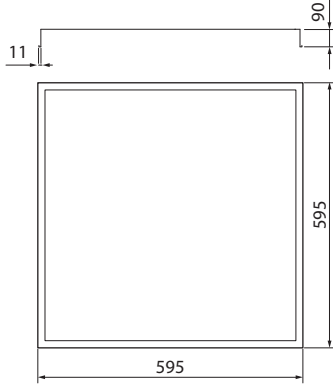

Best Clean C

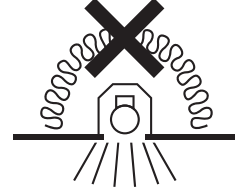
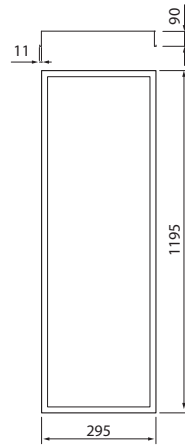

Valaisinta ei saa asentaa suoraan eristemateriaaliin. Denna armatur är inte avsedd för att täckas med värmeisolerande material. The luminaire is not suitable for covering with thermally insulated material.

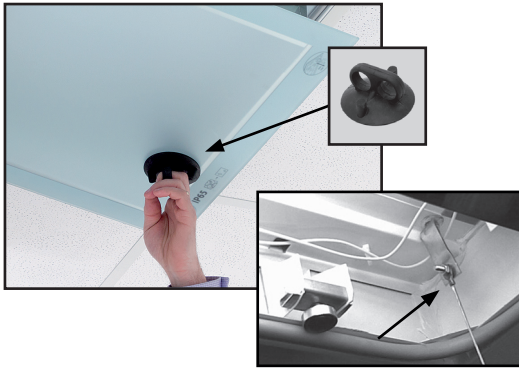

1.

A suction pad is necessary for removing the glass cover from the light fitting (to be ordered separately). **Do not remove the glass cover with a screwdriver! It might break into pieces.** Press the suction pad in the corner of the light fitting and remove the glass – see picture (it is not possible to remove the glass cover if you press the suction pad in the centre of the light fitting). **Do not forget to tighten the safety wires of the glass cover properly!** When mounting the glass cover back into the light fitting, make sure the safety wires do not interfere in the sealing area. Centre the cover before attaching it to the magnets.

Valaisimen saa asentaa vain sähköalan ammattilainen. Käytä ainoastaan syöttöjännitettä ja taajuutta joka on merkitty valaisimeen/liitäntälaitteeseen. Kytke virta pois päältä ennen asennusta tai huoltoa. Tämä asennusohje on säilytettävä ja sen on oltava käytössä asennuksessa ja huollossa. Tämän valaisimen valonlähde ei ole vaihdettavissa. Kun valonlähde rikkoutuu, koko valaisin on poistettava käytöstä.

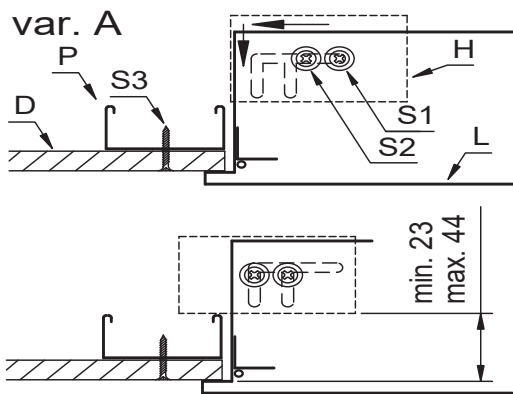

2.

Cut a **D** hole into plasterboard. Insert a **P** plasterboard profile (in order to ensure a better distribution of the weight of the light fitting) and fix it with an **S3** screw. Push an **L** connecting conductor into the light fitting and insert the light fitting into the hole. Unloose the **S1** and **S2** screws. Move the **H** holder according to the arrow. Tighten the **S1** screw slightly. Set the position of the holder, then tighten the **S2** screw and the **S1** screw. Do the same with all the holders. Connect the light fitting to electrical network.

Vi rekommenderar att installationen görs av en behörig elektriker. Använd endast driftspänning och frekvens som är märkt på armaturen/förkopplingsdonet. Bryt stömmen före installation eller service. Denna monteringsanvisning bör sparas och finnas tillgänglig vid installation eller framtida service. Ljuskällan till denna armatur kan inte bytas ut. När ljuskällan når sin livslängd ska hela armaturen bytas ut.

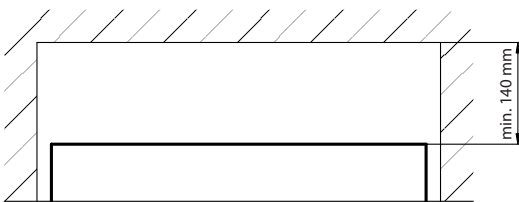

Only a professional electrician is allowed to do the installation. Use only rated voltage and frequency as marked in the fixture/driver. Switch off the current before installation or service. This mounting instruction must be kept available during installation and for future maintenance. The light source of this luminaire is not replaceable; when the light source reaches its end of life the whole luminaire shall be replaced.

Huolto- ja kierrätysohjeet

Underhålls- och återvinningsinstruktioner

Hooldus- ja utiliseerimisjuhend

Maintenance and recycling instructions

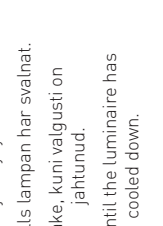
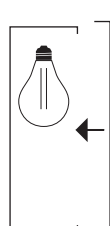
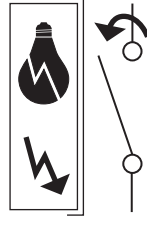
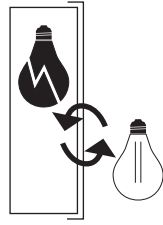
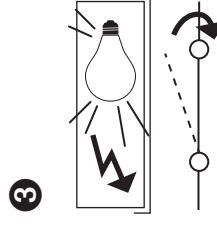
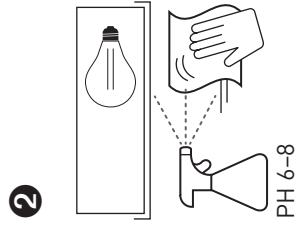
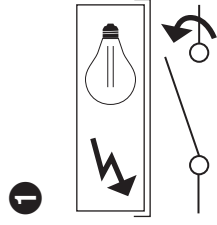
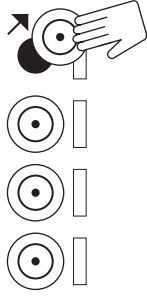
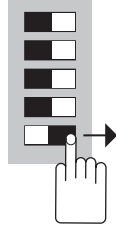
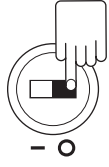
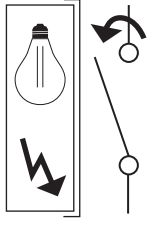

1

2

3

4

Odota, että valaisin on
jäähdytynyt.
Väntä tälls lampan har svalnat.
Oodake, kuni valgusti on
jähtunud.
Wait until the luminaire has
cooled down.

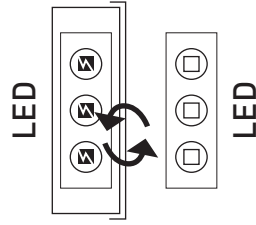

LED

LED

