

## CIO MULTI

IP20

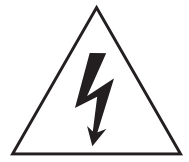

-0



ALASVALO | DOWNLIGHT ARMATUR | DOWNLIGHT

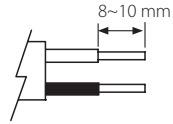
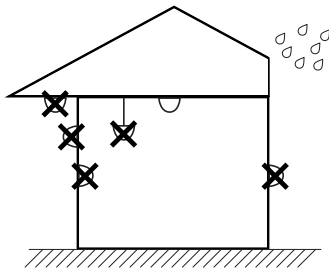

Kytettävä erillisessä rasiassa.  
Inkoppling via separat dosa.  
Connection in a separate terminal box.

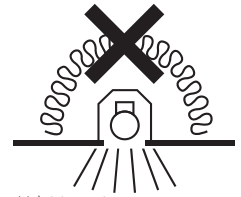

Valaisinta ei saa asentaa suoraan eristemateriaaliin.

Denna armatur är inte avsedd för att täckas med värmeisolerande material.

The luminaire is not suitable for covering with thermally insulated material.

4146601

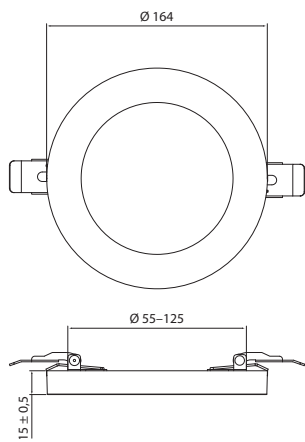

Ø 55-125 mm

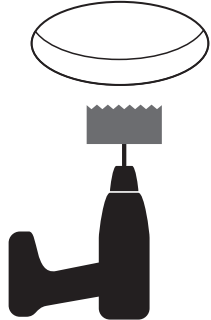

4146602

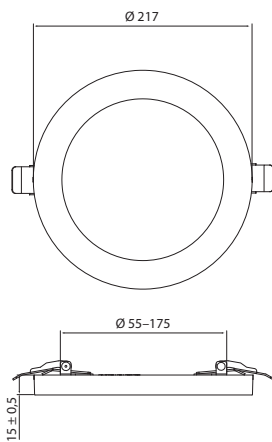

Ø 55-175 mm

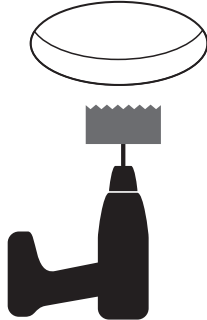

4146603

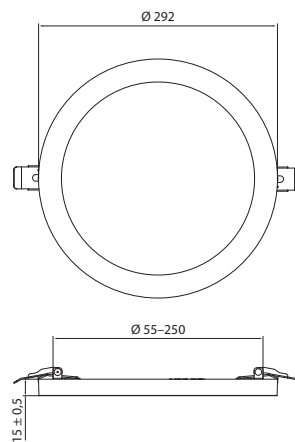

Ø 55-250 mm

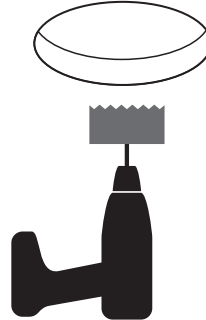
**FI**

Tämä tuote sisältää energiatehokkuusluokan F valonlähteen.

Valaisimen saa asentaa vain sähköalan ammattilainen. Käytä ainoastaan syöttöjännitettä ja taajuutta joka on merkitty valaisimeen/liitäntälaitteeseen. Kytke virta pois päältä ennen asennusta tai huoltoa. Tämä asennusohje on säilytettävä ja sen on oltava käytössä asennuksessa ja huollossa. Tämän valaisimen valonlähde ei ole vaihdettavissa. Kun valonlähde rikkoutuu, koko valaisin on poistettava käytöstä.

**SE**

Denna produkt innehåller en ljuskälla med energieffektivitetsklass F.

Vi rekommenderar att installationen görs av en behörig elektriker. Använd endast driftspänning och frekvens som är märkt på armaturen/förkopplingsdonet. Bryt strömmen före installation eller service. Denna monteringsanvisning bör sparas och finnas tillgänglig vid installation eller framtida service. Ljuskällan till denna armatur kan inte bytas ut. När ljuskällan når sin livslängd ska hela armaturen bytas ut.

**EN**

This product contains a light source of energy efficiency class F.

Only a professional electrician is allowed to do the installation. Use only rated voltage and frequency as marked in the fixture/driver. Switch off the current before installation or service. This mounting instruction must be kept available during installation and for future maintenance. The light source of this luminaire is not replaceable; when the light source reaches its end of life the whole luminaire shall be replaced.

# CIO MULTI

IP20



0.1m

-0

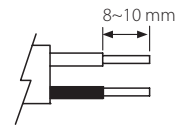
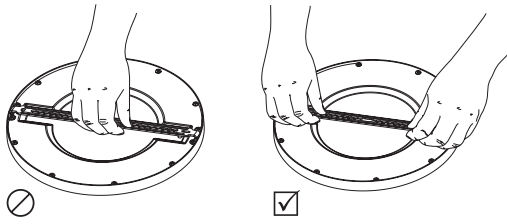
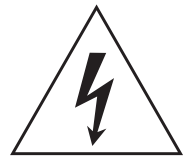

Kytettävä erillisessä rasiassa.  
Inkoppling via separat dosa.  
Connection in a separate terminal box.

Ennen asennusta, irrota kannake valaisimesta.  
Before installation, take out the bracket from panel.

## PINTA-ASENNUS / WITHOUT MOUNTING HOLE

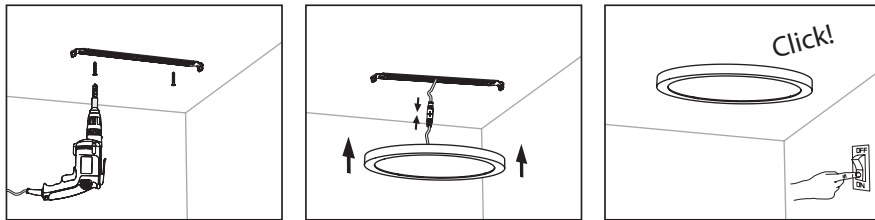

## VALAISIMEN IRROTUS / UNINSTALLING

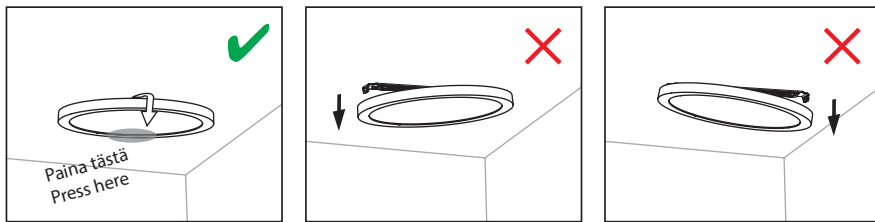

## PUOLIUPPOASENNUS / WITH MOUNTING HOLE READY

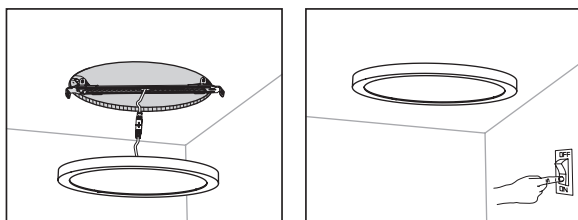
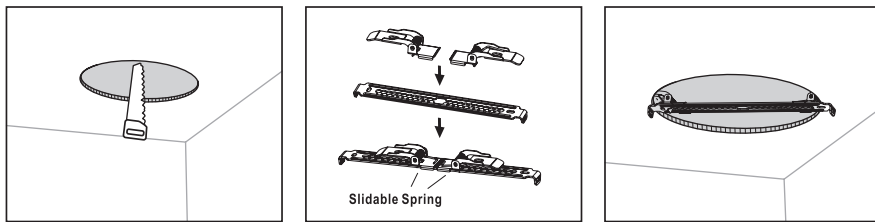

## VALAISIMEN IRROTUS / UNINSTALLING

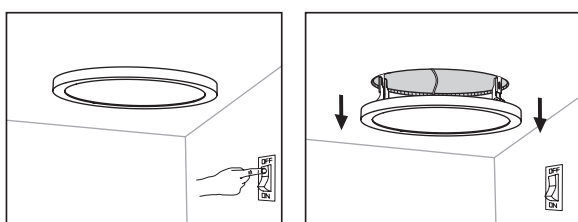

## CCT CHANGE

CW NW WW

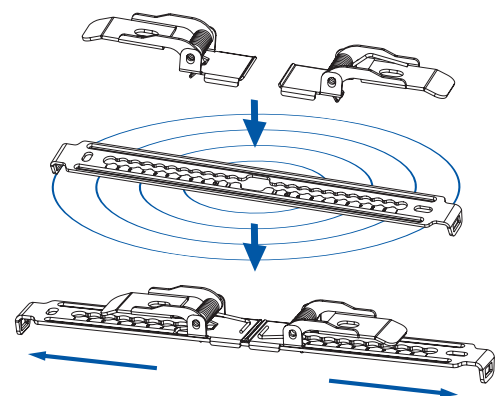
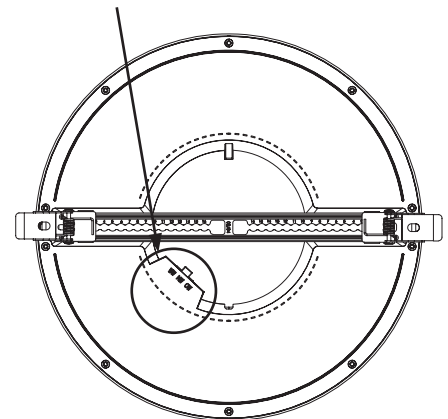
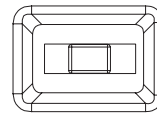

# AIRAM