

Compact Multi

IP20/54  0...25 °C PF≥0.9 

Alasvalo | Downlight armatur | Downlight

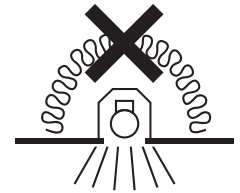
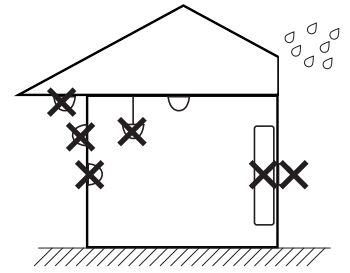
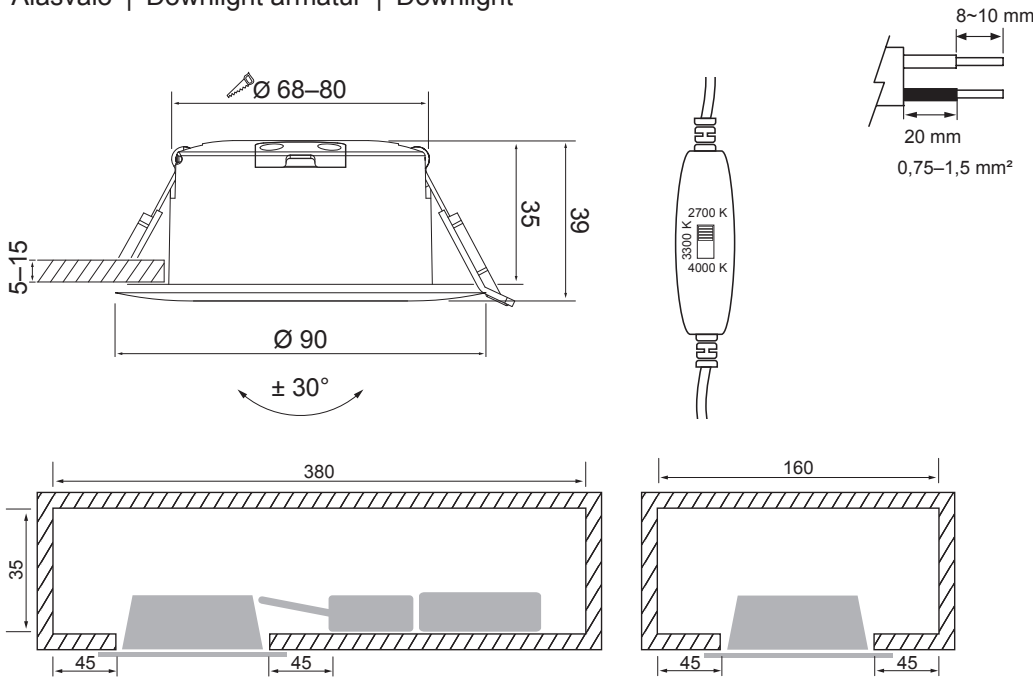

Valaisinta ei saa asentaa suoraan eristemateriaaliin.

Denna armatur är inte avsedd för att täckas med värmeisolerande material.
The luminaire is not suitable for covering with thermally insulated material.

220–240V ~ 50/60 Hz

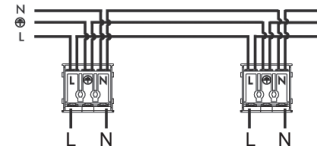

L = ruskea/brun/pruun/brown
N = sininen/blå/sinine/blue

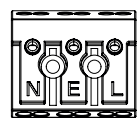

E = Maadoituksen jatkaminen / päättäminen

E = Anslutning / avslutning av jordnings ledning

E = Continuity / termination of earth wires

Valonlähteen vaihto / Replacing the light source / Byte av ljuskällan

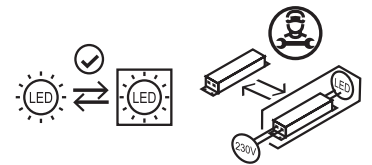
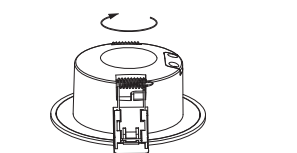
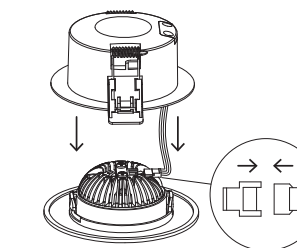
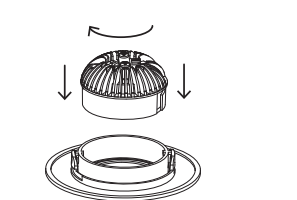
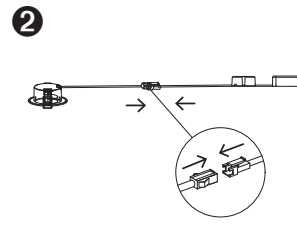
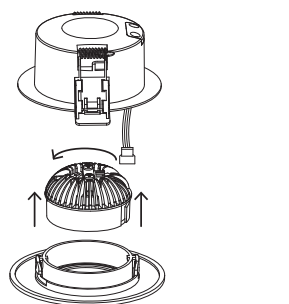
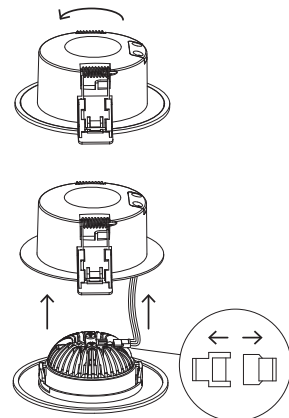
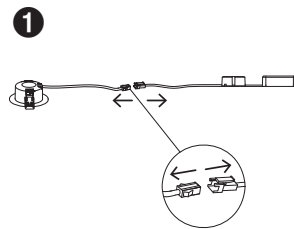

FI Tämä tuote sisältää energiatehokkuusluokan F valonlähteen.

Valaisimen saa asentaa vain sähköalan ammattilainen. Käytä ainoastaan syöttöjännitettä ja taajuutta joka on merkitty valaisimeen/liitäntälaitteeseen. Kytke virta pois päältä ennen asennusta tai huoltoa. Tämä asennusohje on säilytettävä ja sen on oltava käytössä asennuksessa ja huollossa.

SE Denna produkt innehåller en ljuskälla med energieffektivitetsklass F.

Vi rekommenderar att installationen görs av en behörig elektriker. Använd endast driftspänning och frekvens som är märkt på armaturen/förkopplingsdonet. Bryt av strömmen för installation eller service. Denna monteringsanvisning bör sparas och finnas tillgänglig vid installation eller framtida service.

EN This product contains a light source of energy efficiency class F.

Only a professional electrician is allowed to do the installation. Use only rated voltage and frequency as marked in the fixture/driver. Switch off the current before installation or service. This mounting instruction must be kept available during installation and for future maintenance.