

FUTURA EX

IP66 IK10



0-5x2,5



ATEX-VALAISIN | ATEX-ARMATUR | ATEX LUMINAIRE

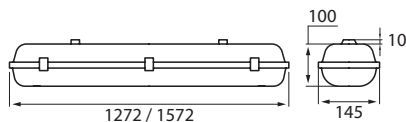

	A [mm]	D [mm]
1.4ft	1272	700
1.5ft	1572	940
2.4ft	1272	700
2.5ft	1572	940

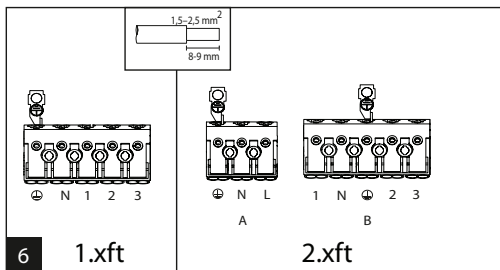
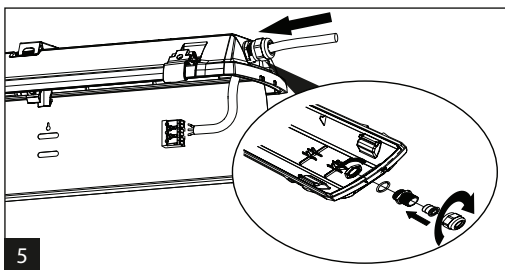
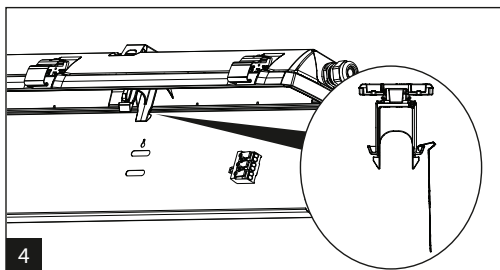
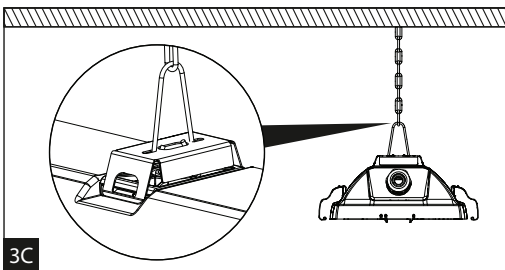
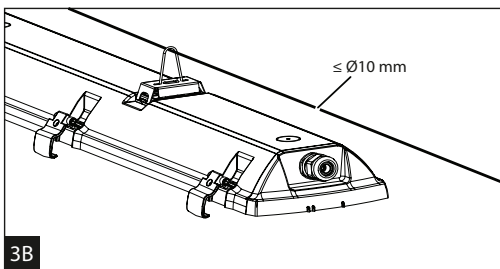
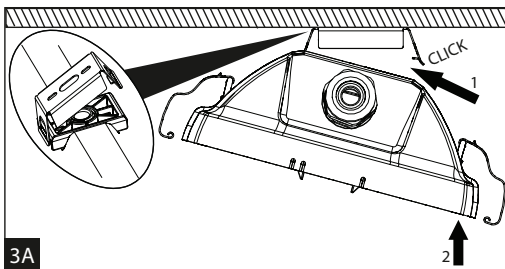
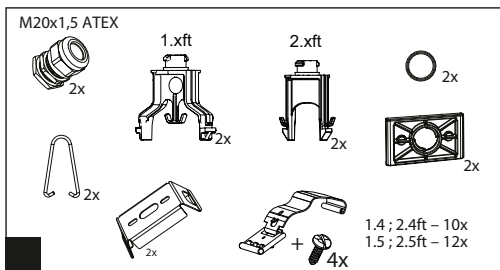
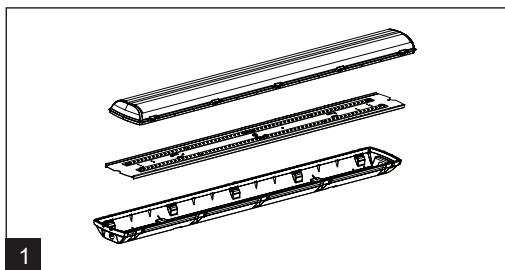
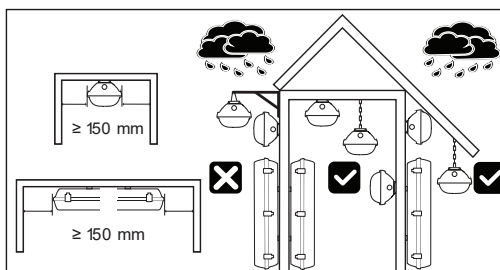

Valaisimen saa asentaa vain sähköalan ammattilainen. Käytä ainoastaan syöttöjännitettä ja taajuutta joka on merkitty valaisimeen/liitäntälaitteeseen. Kytke virta pois päältä ennen asennusta tai huoltoa. Tämä asennusohje on säilytettävä ja sen on oltava käytössä asennuksessa ja huollossa. Tämän valaisimen valonlähde ei ole vaihdettavissa. Kun valonlähde rikkoutuu, koko valaisin on poistettava käytöstä.

Vi rekommenderar att installationen görs av en behörig elektriker. Använd endast driftspänning och frekvens som är märkt på armaturen/förkopplingsdonet. Bryt stömmen före installation eller service. Denna monteringsanvisning bör sparas och finnas tillgänglig vid installation eller framtida service. Ljuskällan till denna armatur kan inte bytas ut. När ljuskällan når sin livslängd ska hela armaturen bytas ut.

Only a professional electrician is allowed to do the installation. Use only rated voltage and frequency as marked in the fixture/driver. Switch off the current before installation or service. This mounting instruction must be kept available during installation and for future maintenance. The light source of this luminaire is not replaceable; when the light source reaches its end of life the whole luminaire shall be replaced.

FUTURA EX

IP66 IK10



-O-
5 x 2,5



ATEX-VALAISIN | ATEX-ARMATUR | ATEX LUMINAIRE

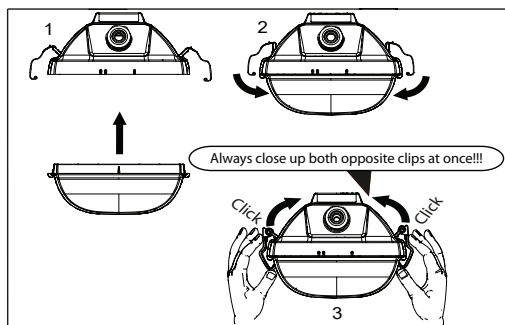
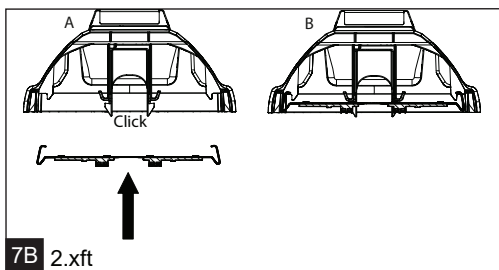
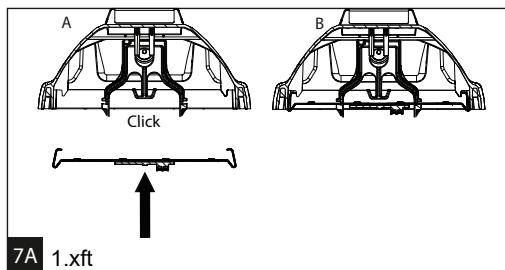

Always close the clips symmetrically from the middle to the sides of the lamp!

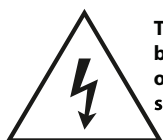
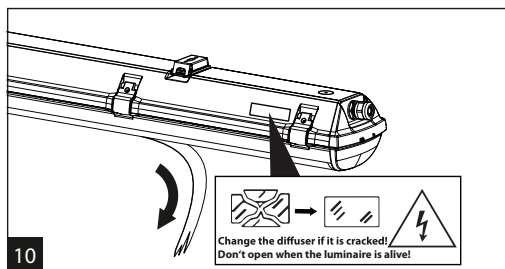
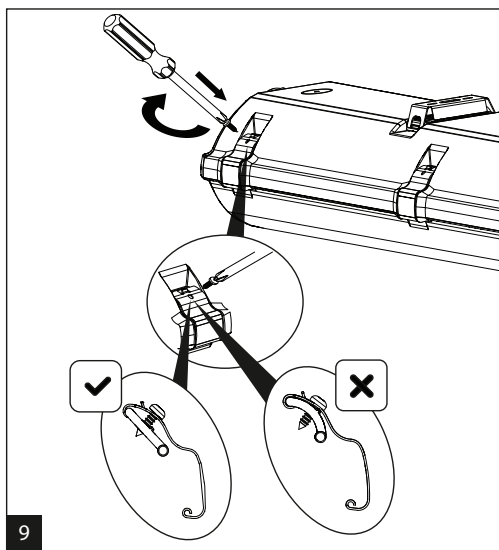
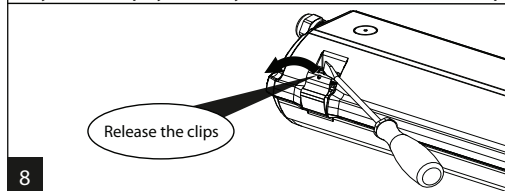

The light source in this luminaire may be replaced only by the manufacturer or its contractual service technician or similarly qualified person!